

Istruzioni per l'installazione
Istruzioni per il montaggio

ref. WC ED 1419
ref. WC ED 1419

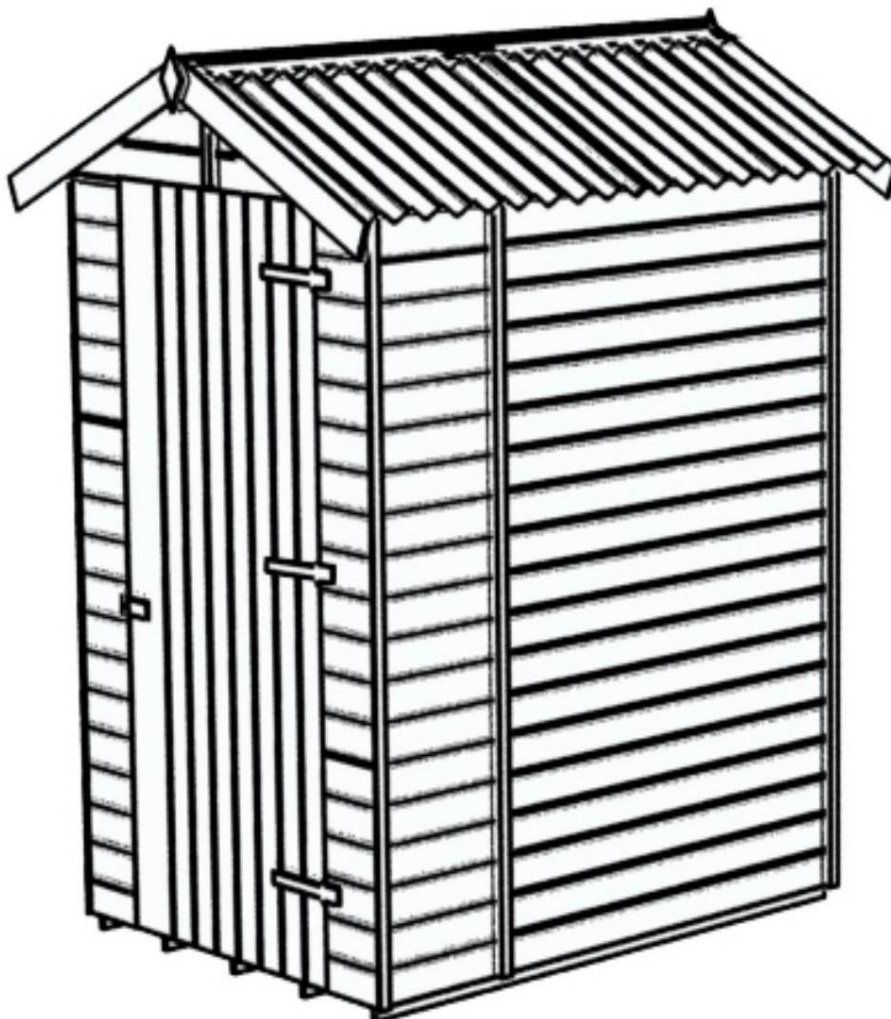

Superficie interna: 1,92 mq

Superficie totale: 2,62 mq

Pendenza del tetto: 13°

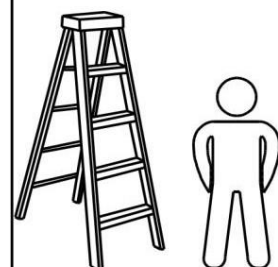
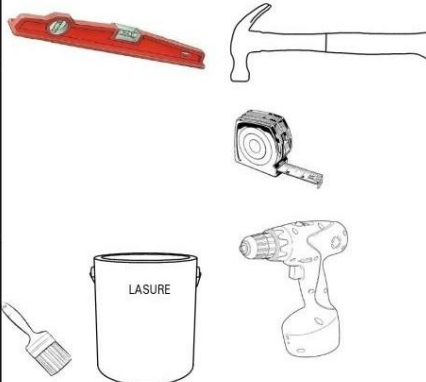

Istruzioni per l'installazione
Istruzioni per il montaggio

ref. WC ED 1419
ref. WC ED 1419

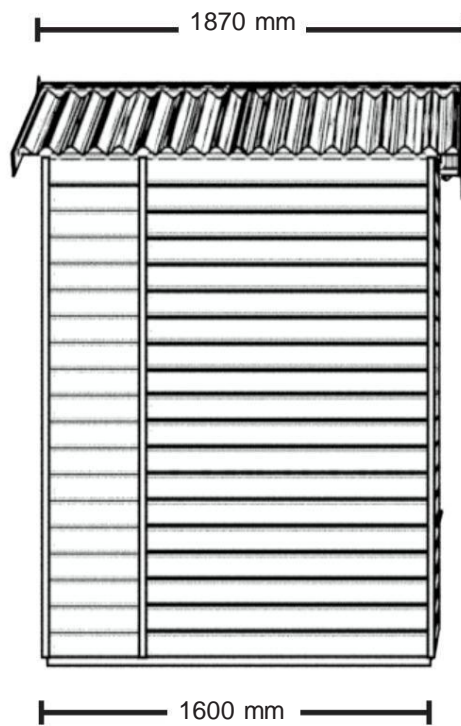
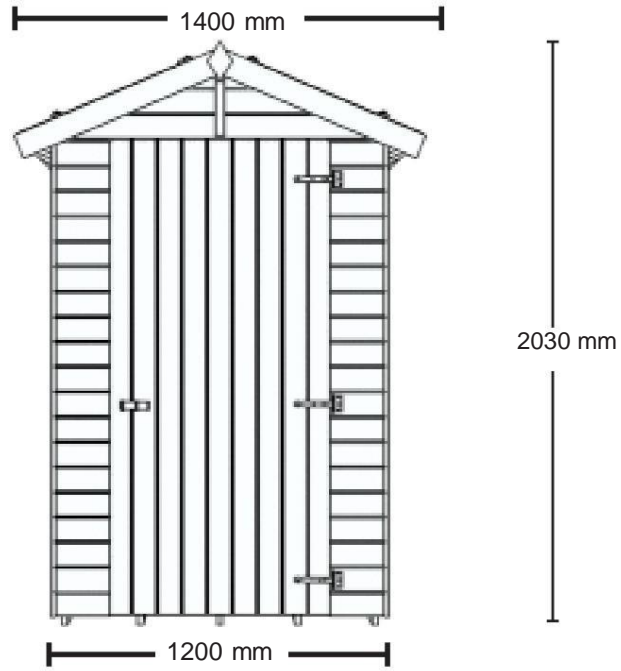



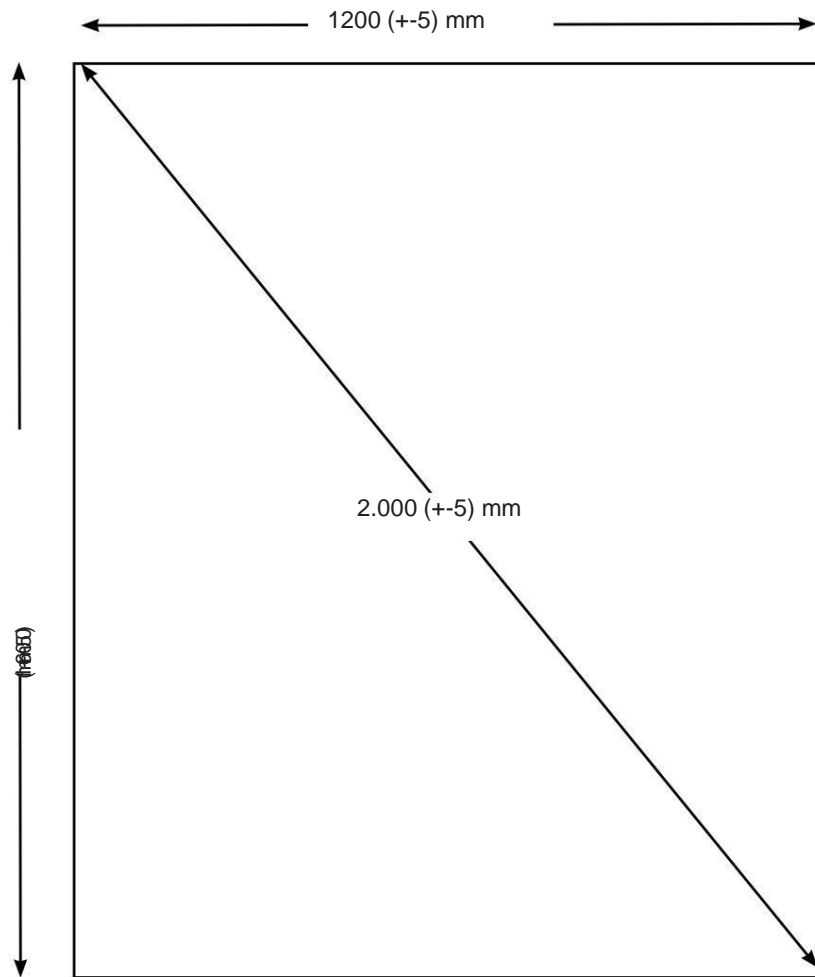



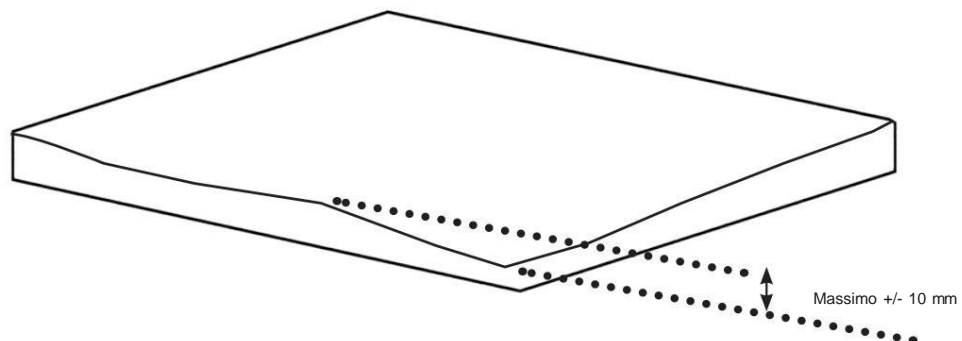

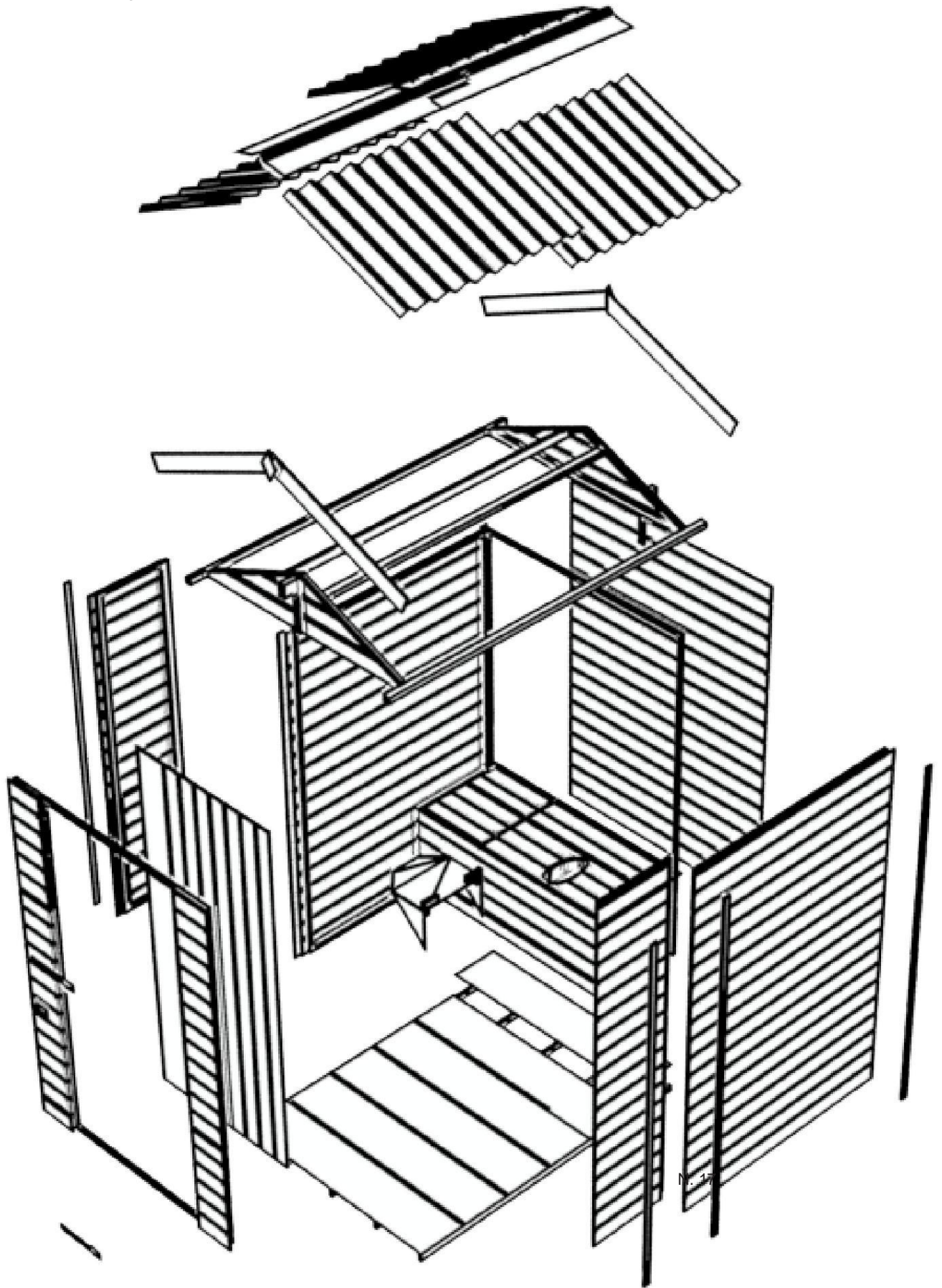









Piano base ED 1419 WC













Le dimensioni riportate sul piano di base sono le dimensioni della soletta in cemento da realizzare su un terreno perfettamente pianeggiante senza nessun altro oggetto esterno come muro, recinzione o albero nelle vicinanze della soletta. Se il prodotto viene installato vicino ad un muro, ad una siepe o ad un albero, è necessario allontanarlo da elementi esterni in modo che possa essere facilmente montato e mantenuto. Si declina ogni responsabilità in caso di errata interpretazione delle dimensioni della lastra.







NO.	RIF	DEL.	SOLE (mm)	QUANTITÀ	PIANO	Richiesta di servizio post-vendita	
						OB	QUANTITÀ
1a	PLS1736.1168		1736X1168X41	1			
1b	PLD1736.1168		1736X1168X41	1			
2a	PS1736.425		1736X425X41	1			
2b	PF1736.425		1736X425X41	1			
4	PF1736.1200		1736X1200X41	1			
5	F16.1120.273		1120X273X56	2			
6	UD1690.800		790x1736x32	1			
7	DSF1736.40		1736x40x8	6			
8	DSF800.90		800x90x16	4			
9	DSF770.60		770x60x16	4			
10	GL1770.40		1770X40X40	2			
11	GL1568.40		1168X46X40	2			
12	DV266		266X70X56	2			
13	OND664.970		970x664x30	4			
15	1000x330x30		1000x330x30	1			
16	500x330x30		500x330x30	1			
17	GP1568.40.25		1568X40X25	5			
18	OSB1168.261		1168X261X12	6			

Dettaglio busta della ferramenta

19	Vite 4x45		4x45	52			
20	Vite 3,5x35		3,5x35	12			
21	Vite 5 x 60		5x60	4			
22	Vite 3,0 x 30		3x30	78			
23	Chiodi L40		4x40	60			
24	Chiodi L16		2x16	20			
25	Fermo		90x60	1			
26	Chiodi a testa sagomata		50x4	45			
27	Cerniere		100x60	3			
28	R150,90		150x90	2			

Da compilare per ogni richiesta di servizio post-vendita e inviare via email a

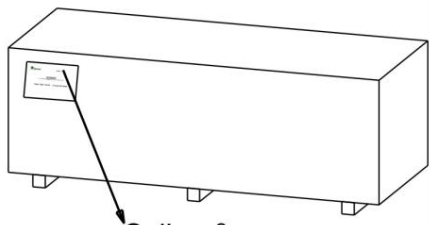
sav@foresta.fr + foto delle parti danneggiate (da compilare tassativamente + foto delle parti danneggiate)

 <p>Colis n°: _____</p>	<p>WC ED 1419</p> <p>Numero del pacchetto _____</p>	NEGOZIO	
		NOME (NOME) CLIENTE	
		NOME (PRIMO NOME) CLIENTE	
		COME. 	

EDEN 1419.01

FORESTA

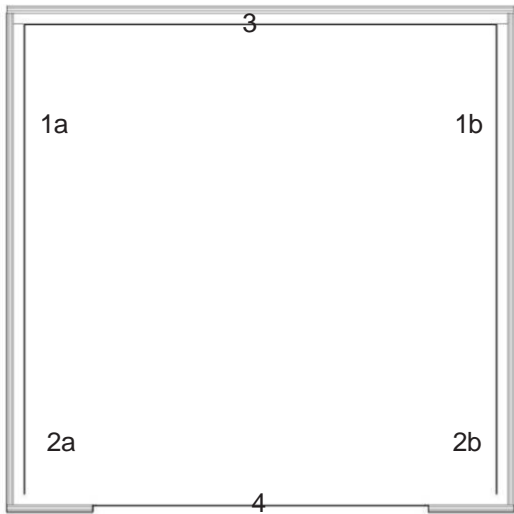

22 – 60 pz

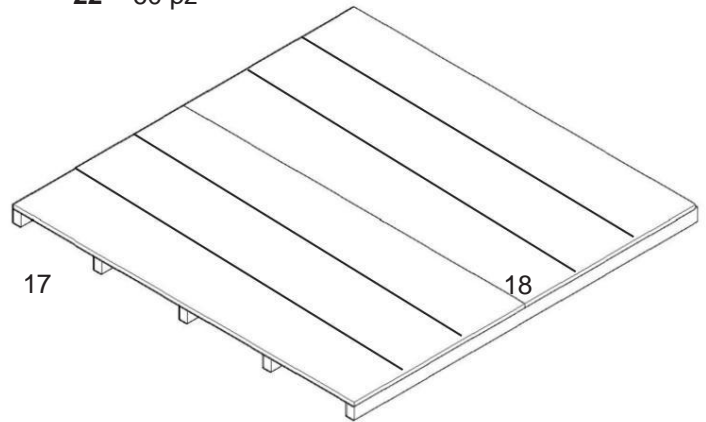

19 – 12 pz

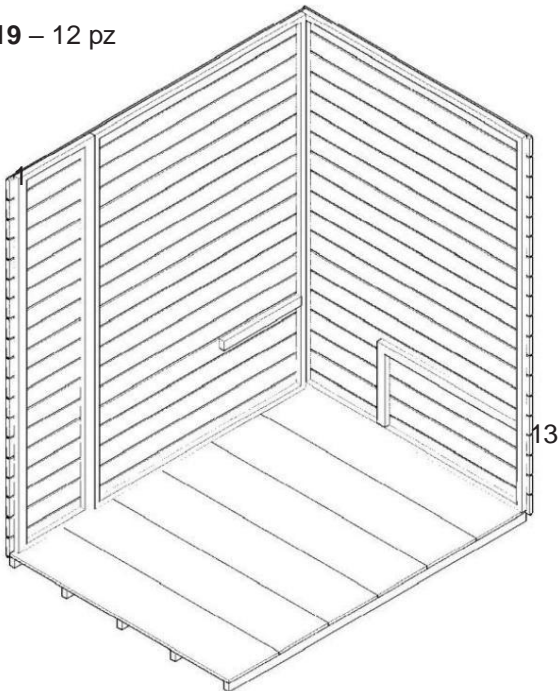

19 – 10 pz

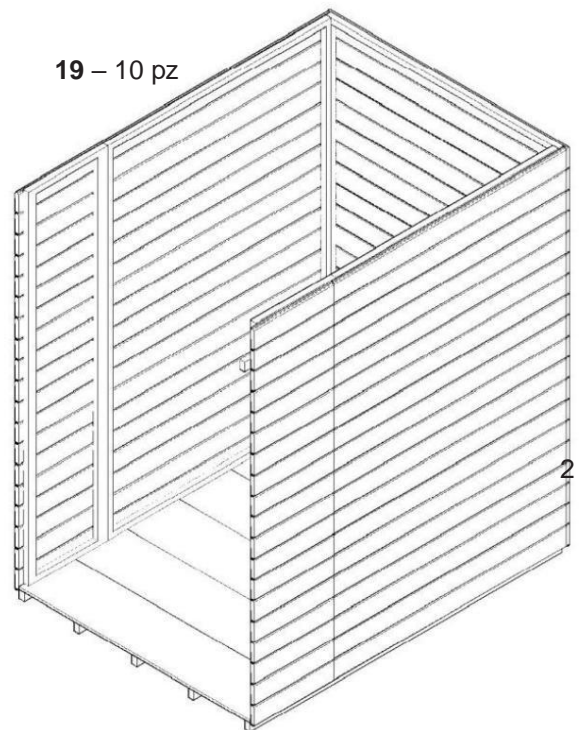

19 – 8 pz
21 – 4 pz

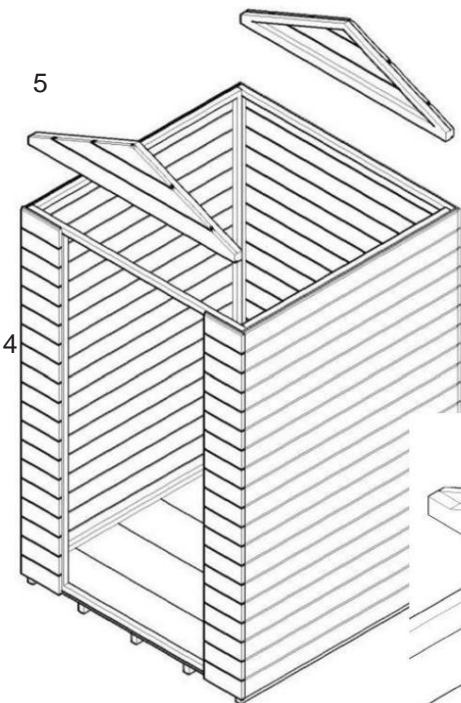

19 – 12 pezzi 10

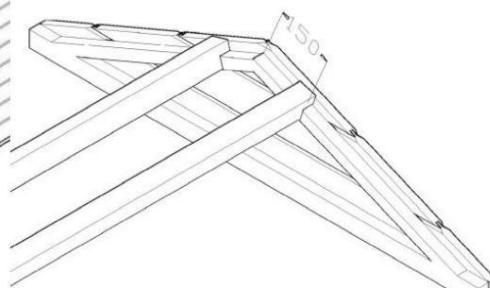
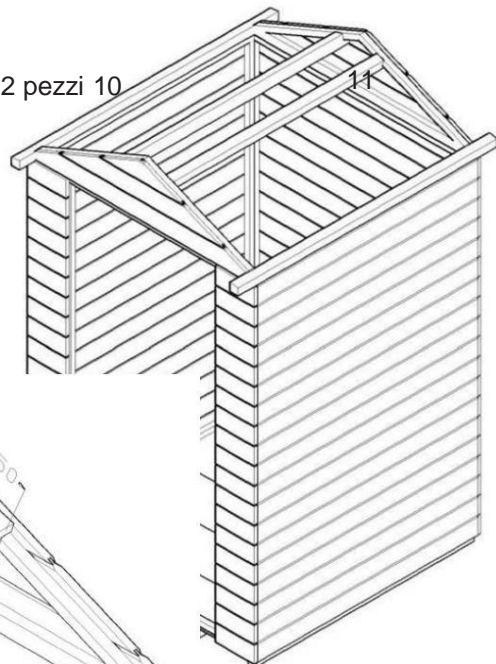

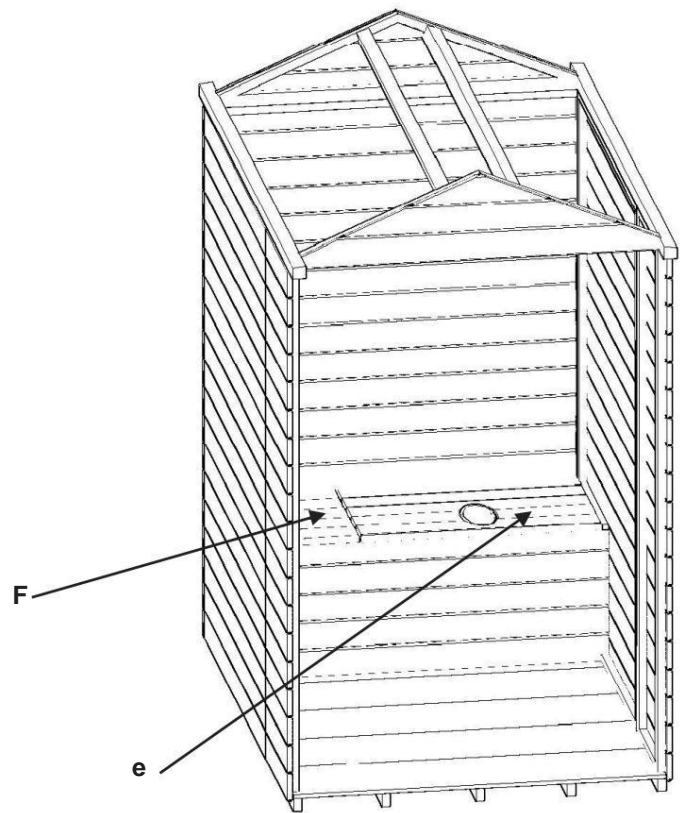
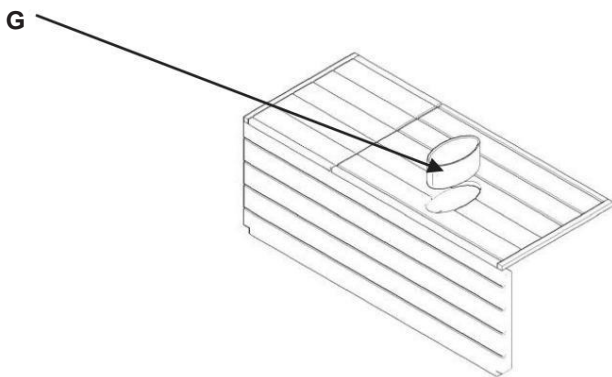
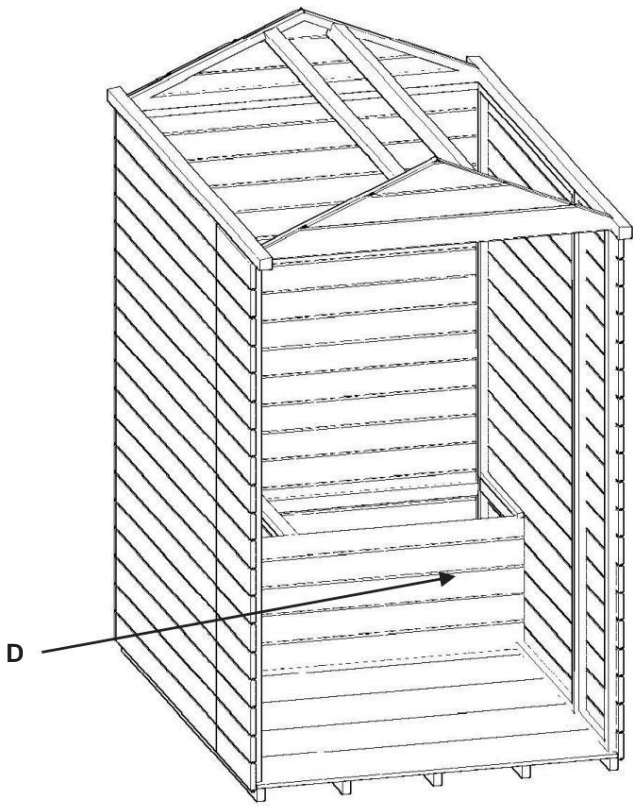
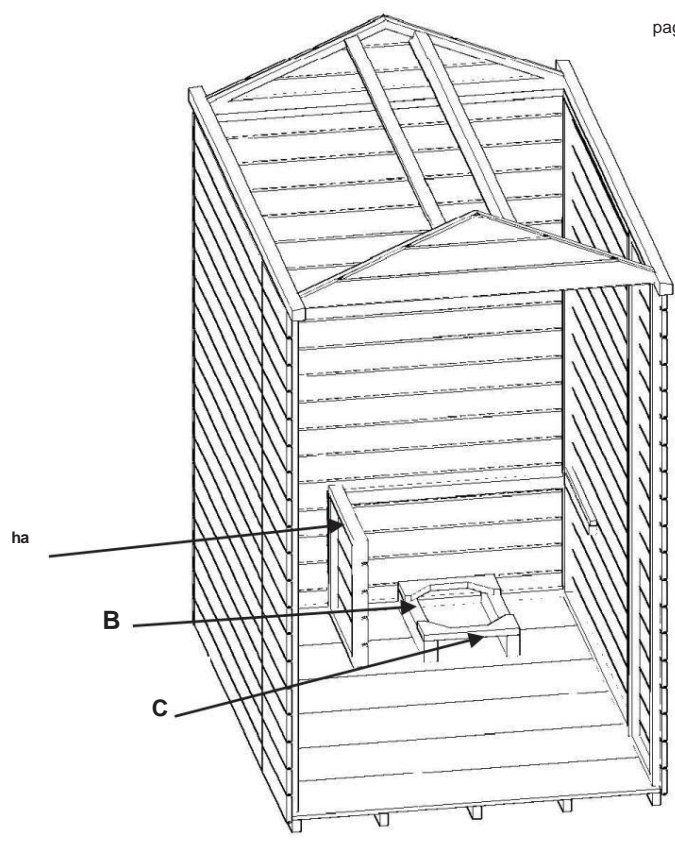

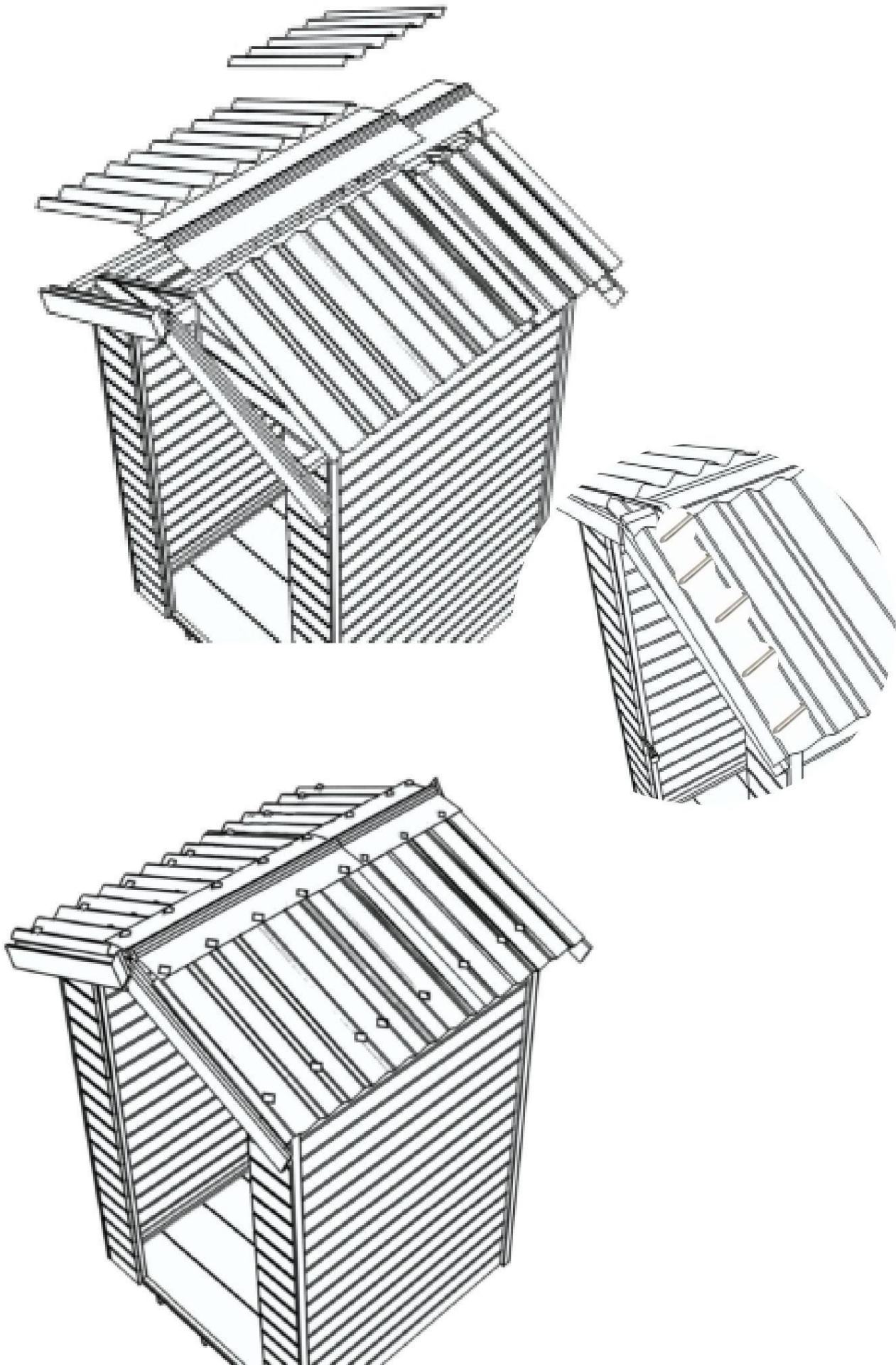

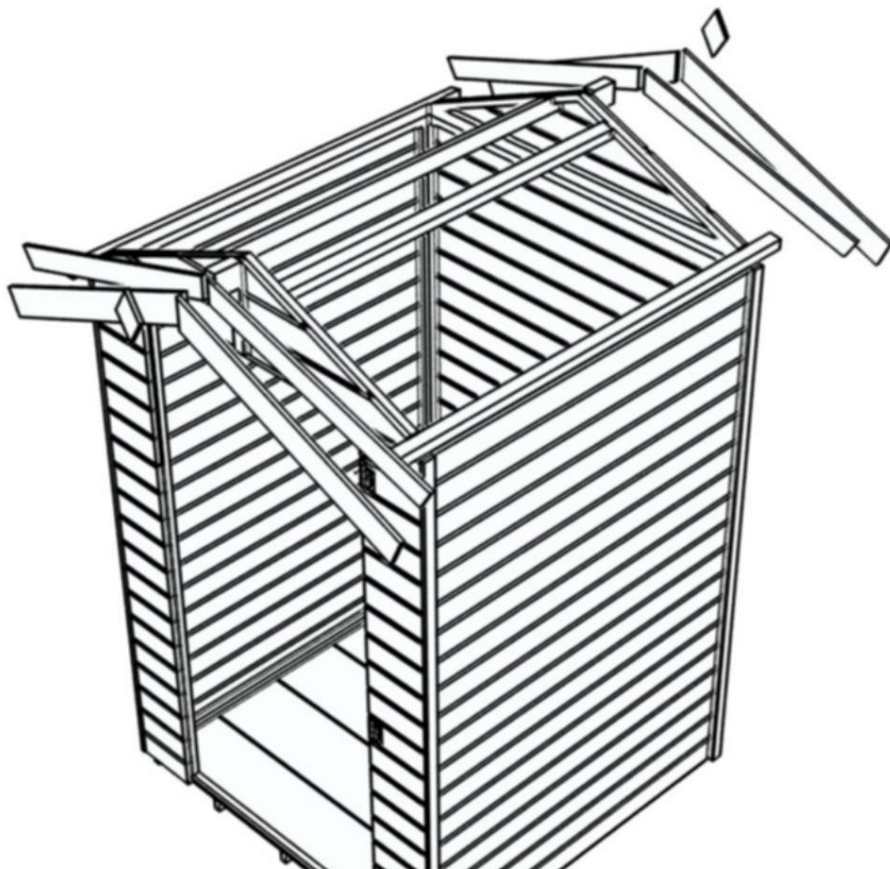
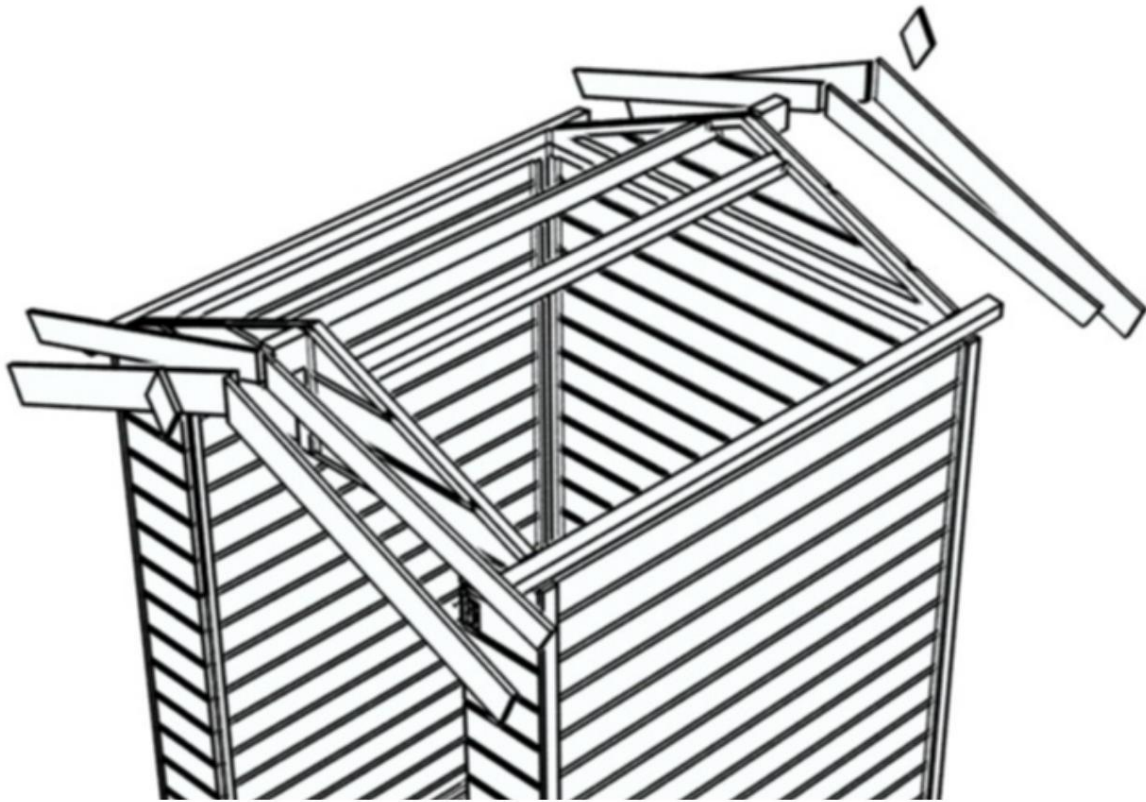

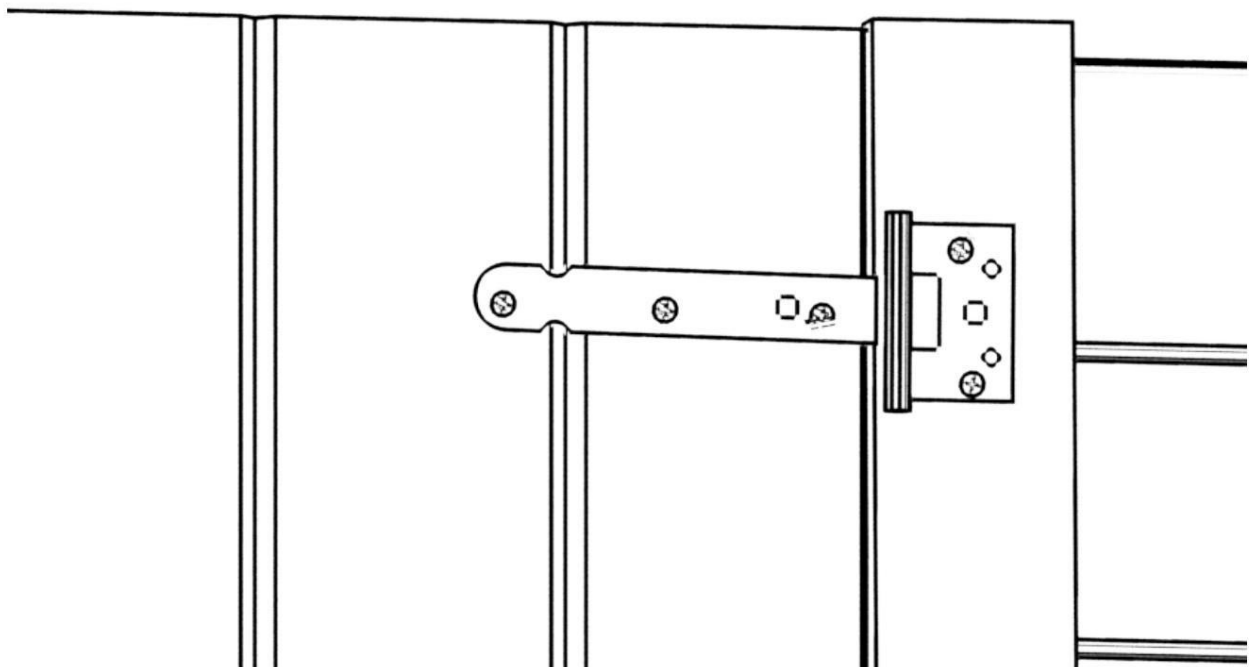
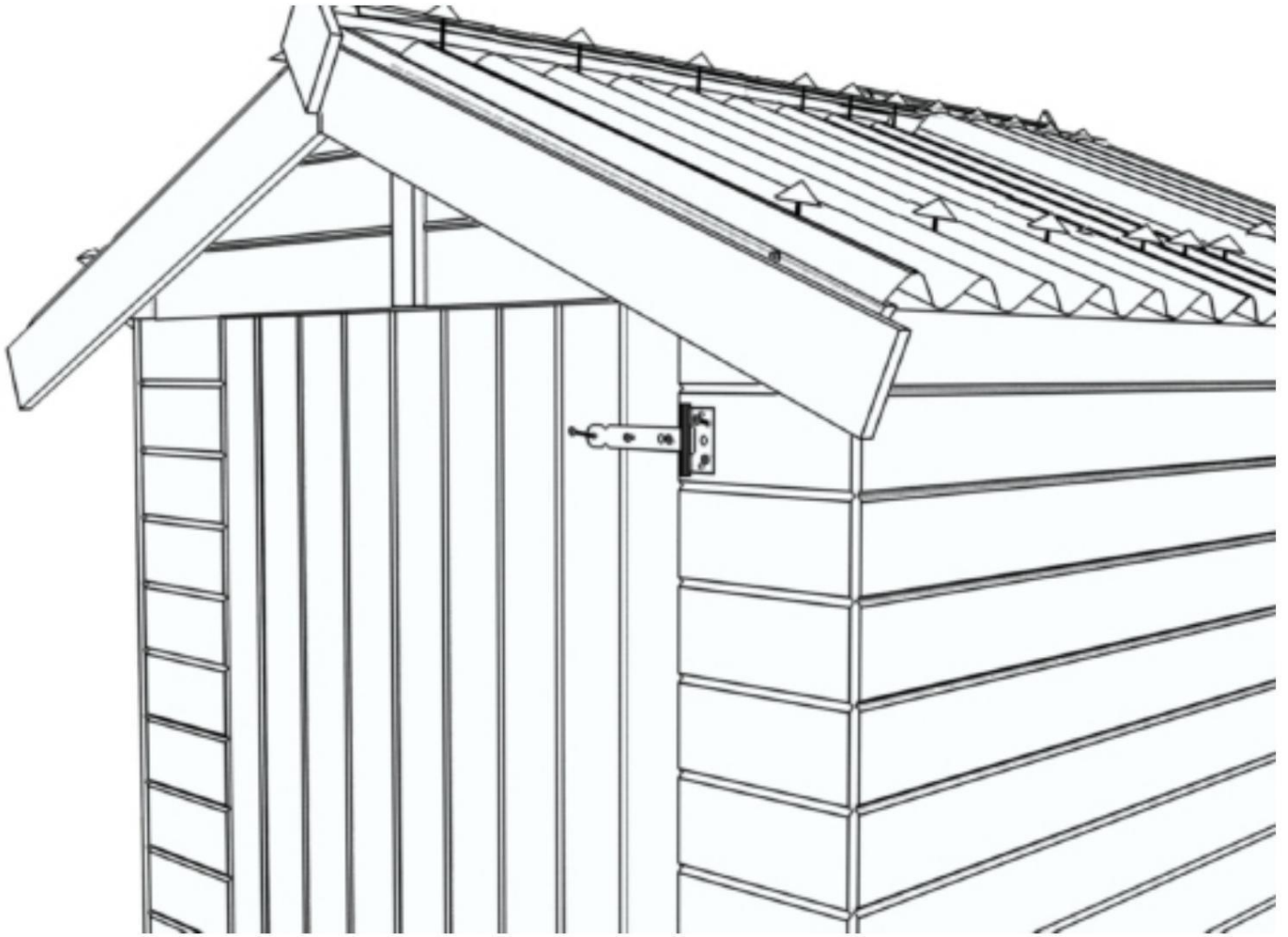

EDEN 1419.01

24, - 20
pz . 26 ,- 4 5 pz

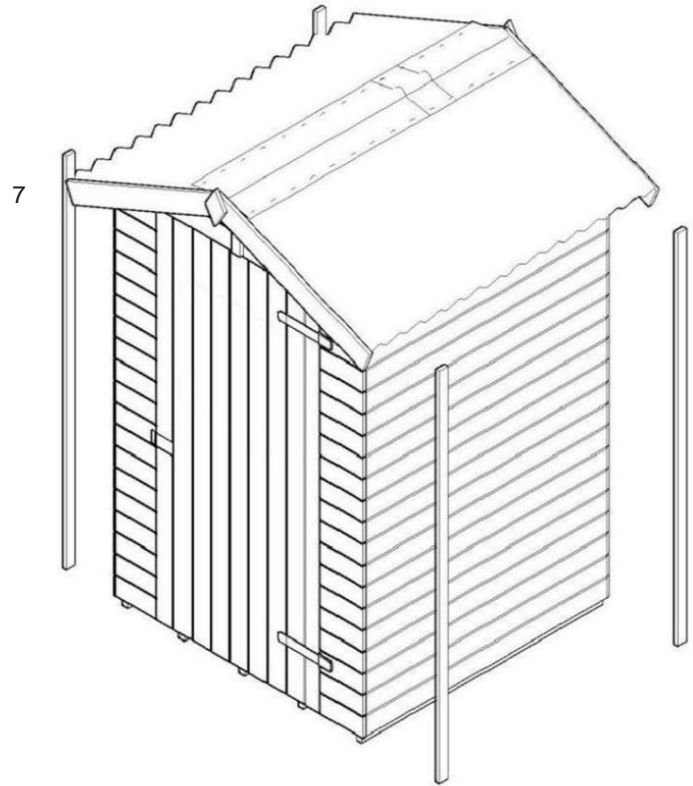
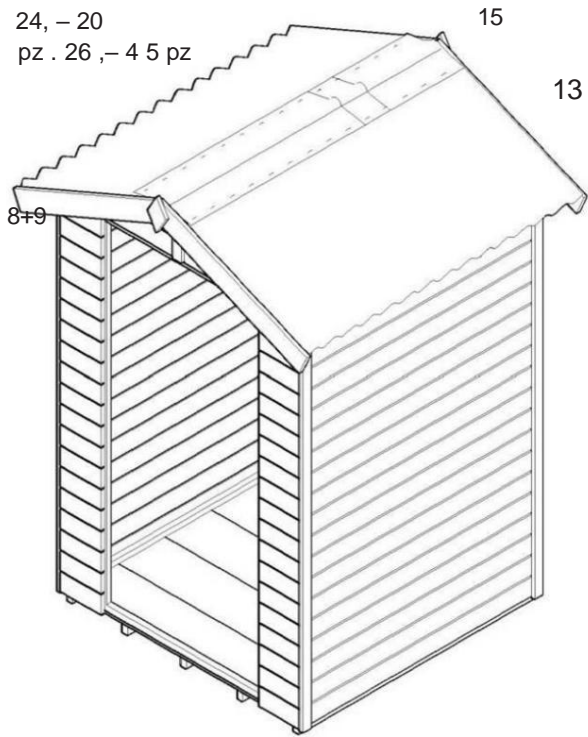

23,- 60 pz

27 - 2 pz
20 - 12 pz
22 - 9+9 pz
25 - 1 pz

